

MAF401 A / D / M series

AIR UNIT (AIR / MIST / MICROMIST FILTER)

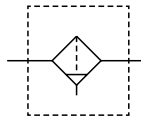

Symbol



A: 5µm

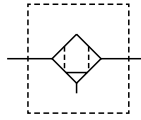

D: 0.3µm

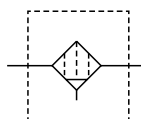

M: 0.01µm

- MAF401A is designed for draining and removal of foreign matter. (Element: 5µm)
- MAF401D/M is designed for removal of foreign matter as well as oil mist (Element: 0.3µm / 0.01µm)

Specification

Model	MAF401A/D/M		
Bore No.	8A	10A	15A
Port size	1 / 4	3 / 8	1 / 2
Medium	Air		
Operating pressure range (*)	0.05~1 MPa		
Proof pressure	2 MPa		
Ambient temperature	-5~+60°C (No freezing)		
Filter element	5 µm , 0.3 µm , 0.01 µm		
Weight	480 g		

* Standard unit contains semi-auto-drain function when operating pressure below 0.05 MPa.

* Choose auto-drain FMRF300, the pressure range is 0.15 ~ 1 MPa.

Order example

MAF401D-8A-□-D-□-□

MODEL

BORE SIZE

8A: 1/4
10A: 3/8
15A: 1/2

D: Auto drain valve (FMRF300)

PORT THREAD

Blank: Rc thread
G: G thread
NPT: NPT thread

FILTER ELEMENT

A: 5 µm
D: 0.3 µm
M: 0.01 µm

EXTERIOR COLOR

Blank: Black & silver
W: Gray & white

B: C type bracket

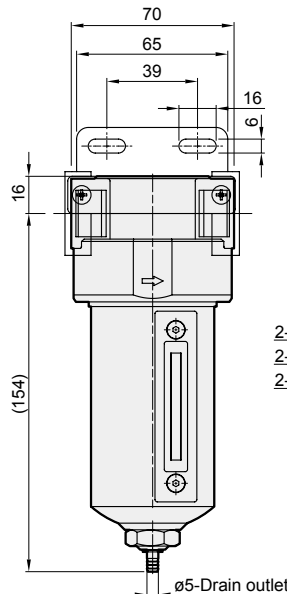
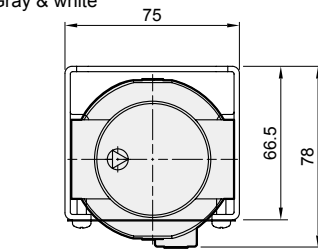

2-Rc1/4
2-Rc3/8
2-Rc1/2

Option accessories

C type bracket

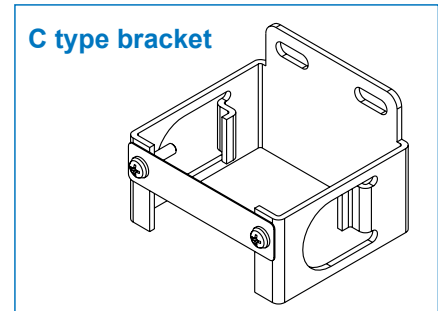

MAF401 A / D / M Capacity

AIR UNIT (AIR / MIST / MICROMIST FILTER)



Flow feature

MAF401A (Filter element: 5 μm)

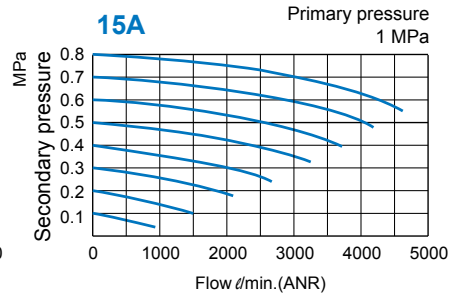
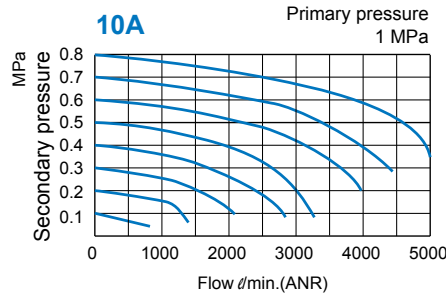
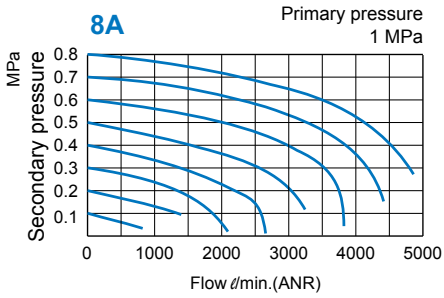

MAF401D (Filter element: 0.3 μm)

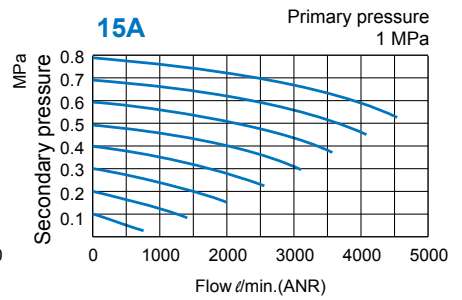
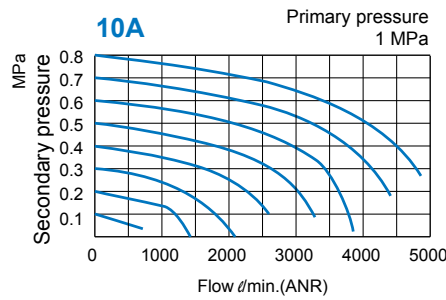
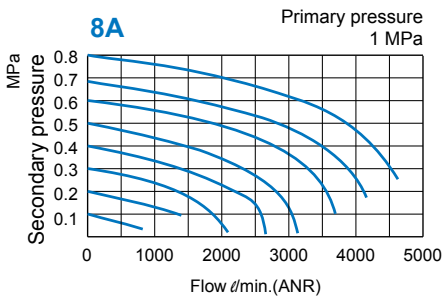

MAF401M (Filter element: 0.01 μm)

