

# End-position controllers CPX-CMPX

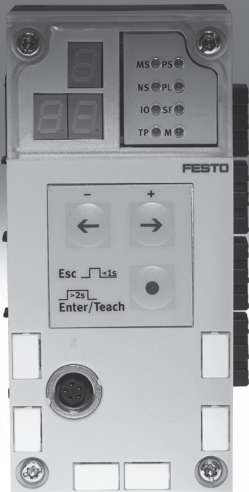

# End-position controllers CPX-CMPX

Overview

FESTO

## Servo-pneumatic drive technology

Positioning and Soft Stop applications as an integral component of the valve terminal CPX – the modular peripheral system for decentralised automation tasks.

The modular design means that valves, digital inputs and outputs, positioning modules and end-position controllers, as appropriate to the application, can be combined in almost any way on the CPX terminal.

### Advantages:

- Pneumatics and electrics – control and positioning on one platform
- Innovative positioning technology – piston rod drives, rodless drives, rotary drives
- Actuation via fieldbus
- Remote maintenance, remote diagnostics, web server, SMS and e-mail alert are all possible via TCP/IP
- Modules can be quickly exchanged and expanded without altering the wiring

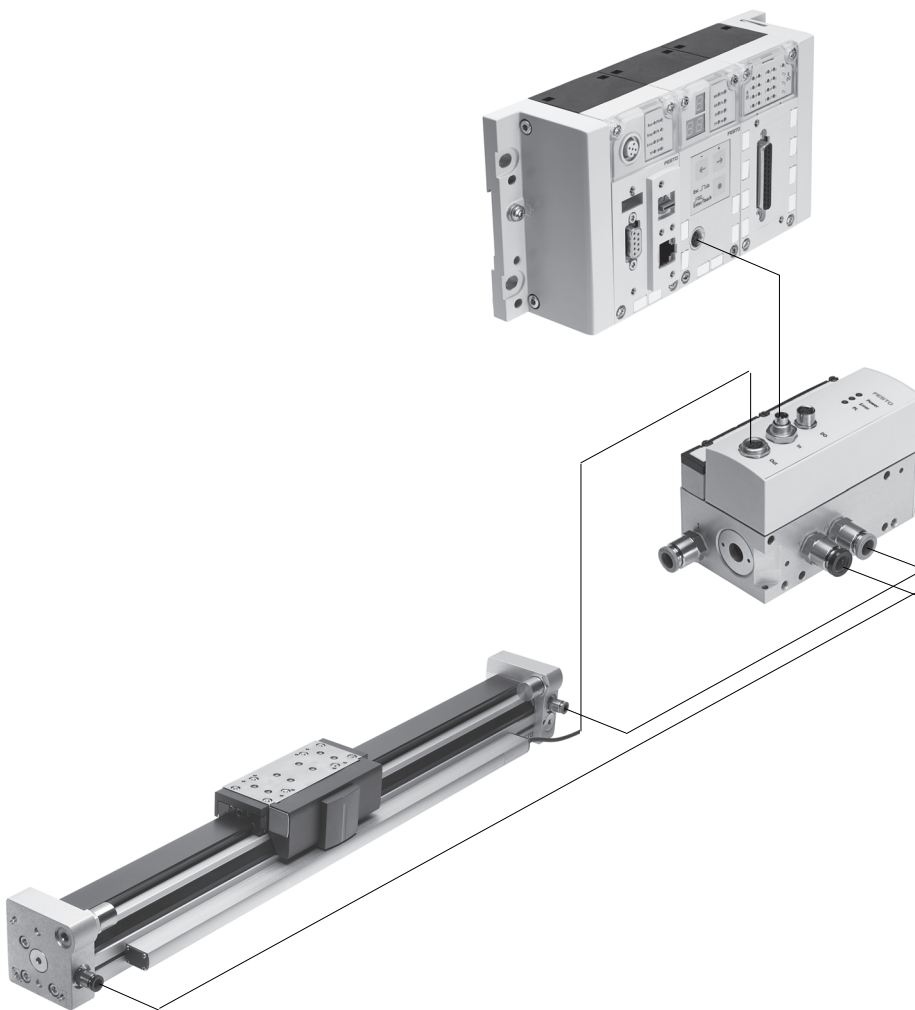

# End-position controllers CPX-CMPX

Key features

FESTO

## Axis controllers CPX-CMAX



**Free choice:**  
Position and force control, directly actuated or selected from one of 128 configurable position sets. If you are looking for something more: the configurable function for switching to the next set enables simple functional sequences to be realised in the axis controller CPX-CMAX. Everything is recognisable: the auto-identification function identifies each station with its device data on the controller CPX-CMAX.

**Also included:**  
The functional scope of the controller CPX-CMAX includes actuation of a brake or clamping unit via the proportional directional control valve VPWP. Up to 7 modules (max. 7 axes) can be operated in parallel and independently of each other. Commissioning via FCT (Festo configuration software) or via fieldbus: no programming, only configuration.

Technical data → Internet: [cpx-cmax](#)

- Advantages:**
- Greater flexibility
  - OEM friendly – commissioning also via fieldbus
  - Clear installation and fast commissioning
  - Cost-effective
  - You program the system in your PLC environment

## End-position controllers CPX-CMPX



**Fast travel between the mechanical end stops of the cylinder, stopping gently and without impact in the end position.**  
Fast commissioning via control panel, fieldbus or handheld unit. Improved control of downtime. Actuation of a brake or clamping unit via the proportional directional control valve VPWP is an integral component of the controller CMPX.

Depending on the fieldbus chosen, up to 9 end-position controllers can be actuated on the CPX terminal. All system data can be read and written via the fieldbus, including, for example the mid positions.

Technical data → 7

- Advantages:**
- Greater flexibility
  - OEM friendly – commissioning also via fieldbus
  - Clear installation and fast commissioning
  - Cost-effective
    - Up to 30% faster cycle rates
    - Significantly reduced system vibration
  - Improved work ergonomics thanks to significantly reduced noise level
  - The extended diagnostics help to reduce the service time of the machine

## Proportional directional control valve VPWP



The 5/3-way proportional directional control valve for applications with Soft Stop and pneumatic positioning. Fully digitalised – with integrated pressure sensors, with new diagnostic functions. In sizes 4, 6 and 8. Flow rate of 350, 700 and 1400 l/min.

With switching output for actuating a brake. Coloured supply ports. Pre-assembled cables guarantee faultless and fast connection with the controllers CPX-CMPX and CPX-CMAX.

Technical data → Internet: [vpwp](#)

- Advantages:**
- Clear installation and fast commissioning
  - Reduction of system downtimes thanks to the new diagnostic options
  - With switching output for actuating a brake/clamping unit

# End-position controllers CPX-CMPX

Drive options

**FESTO**

## System with linear drive DDLI, DGCI

Technical data → Internet: [ddli](#) or [dgci](#)

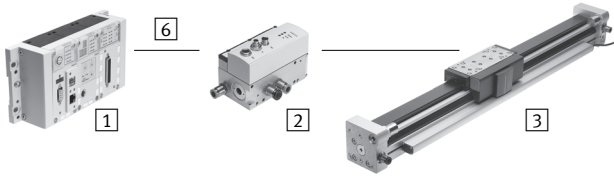

- 1 Controller module CPX-CMPX or CPX-CMAX
- 2 Proportional directional control valve VPWP
- 3 Linear drive DDLI, DGCI with displacement encoder
- 6 Connecting cable KVI-CP-3...

- Pneumatic rodless linear drive with displacement encoder, with or without recirculating ball bearing guide
- Displacement encoder with absolute and contactless measurement
- Diameters:
  - DGCI: 18 ... 63 mm
  - DDLI: 25 ... 63 mm
- Stroke: 100 ... 2000 mm in fixed lengths
- Range of applications: Soft Stop and pneumatic positioning
- Loads from 1 ... 180 kg
- No sensor interface required

Advantages:

- Complete drive unit
- DDLI for easy connection to customer's guide system
- Excellent running characteristics
- For fast and accurate positioning down to  $\pm 0.2$  mm (only with axis controller CPX-CMAX)

## System with standard cylinder DNCI, DDPC

Technical data → Internet: [dnci](#)

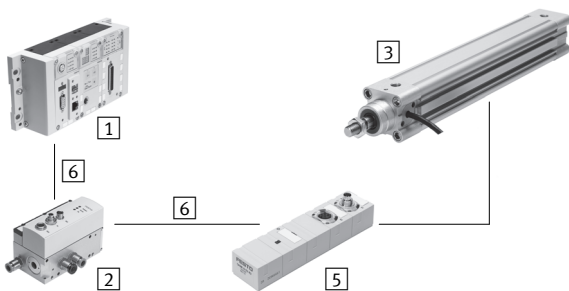

- 1 Controller module CPX-CMPX or CPX-CMAX
- 2 Proportional directional control valve VPWP
- 3 Standard cylinder DNCI, DDPC with displacement encoder
- 5 Sensor interface CASM-S-D3-R7
- 6 Connecting cable KVI-CP-3...

- Standard cylinder with integrated displacement encoder, conforms to DIN ISO 6432, VDMA 24 562, NF E 49 003.1 and Uni 10 290
- Displacement encoder with contactless and incremental measuring
- Diameter: 32 ... 100 mm
- Stroke: 100 ... 750 mm
- Range of applications: Soft Stop and pneumatic positioning
- Loads from 3 ... 450 kg and a matching sensor interface CASM-S-D3-R7
- Pre-assembled cables guarantee faultless and fast electrical connection

Advantages:

- Compact drive unit
- Can be used universally
- Also with guide unit
- For fast and accurate positioning up to  $\pm 0.5$  mm (only with axis controller CPX-CMAX)

# End-position controllers CPX-CMPX

Drive options

FESTO

## System with swivel module DSMI

Technical data → Internet: [dsmi](#)

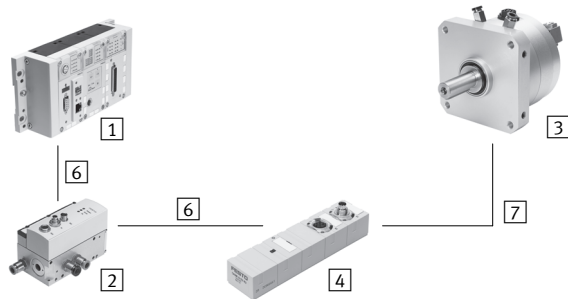

- 1 Controller module CPX-CMPX or CPX-CMAX
- 2 Proportional directional control valve VPWP
- 3 Swivel module DSMI with displacement encoder
- 4 Sensor interface CASM-S-D2-R3
- 6 Connecting cable KVI-CP-3-...
- 7 Connecting cable NEBC-P1W4-K-0,3-N-M12G5

- Swivel module DSMI with integrated displacement encoder
- Identical construction as pneumatic swivel module DSM
- Absolute displacement encoder on basis of potentiometer
- Swivel range from 0 ... 270°
- Size: 25, 40, 63
- Max. torque: 5 ... 40 Nm
- Range of application of Soft Stop and pneumatic positioning: mass moments of inertia from 15 ... 6000 kgcm<sup>2</sup> and the matching sensor interface CASM-S-D2-R3
- Pre-assembled cables guarantee faultless and fast connection with the proportional directional control valve VPWP

- Advantages:
- Complete drive unit, compact, can be used immediately
  - High angular acceleration
  - With adjustable fixed stops
  - For fast and accurate positioning down to ±0.2° (only with axis controller CPX-CMAX)

## System with potentiometer

Technical data → Internet: [casm](#)

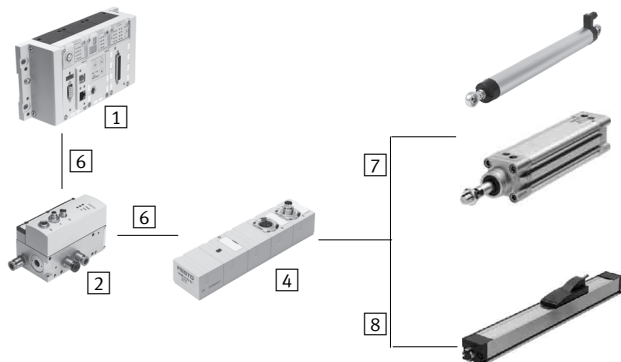

- 1 Controller module CPX-CMPX or CPX-CMAX
- 2 Proportional directional control valve VPWP
- 4 Sensor interface CASM-S-D2-R3
- 6 Connecting cable KVI-CP-3-...
- 7 Connecting cable NEBC-P1W4-K-0,3-N-M12G5
- 8 Connecting cable NEBC-A1W3-K-0,4-N-M12G5

- Attachable potentiometers with absolute measurement, with high degree of protection
- With connecting rod or moment compensator
- Measuring range:  
Connecting rod: 100 ... 750 mm  
Moment compensator: 225 ... 2000 mm
- Pre-assembled cables guarantee faultless and fast connection with the sensor interface CASM
- Range of applications: Soft Stop and pneumatic positioning with cylinder Ø 25 ... 80 mm, e.g. DNC or DSBC
- Loads from 1 ... 300 kg

- Advantages:
- Easy installation and fast commissioning
  - Cost-effective
  - Can also be used in harsh ambient conditions
  - Variety of drives: CPX-CMPX and CPX-CMAX also support cylinders with external displacement encoder

# End-position controllers CPX-CMPX

Drive options

System components for Soft Stop systems with end-position controller CPX-CMPX							
3		Linear drive	Standard cylinder	Swivel module	Displacement encoder		→ Page/ Internet
		DDLI/DGCI	DNCI/DDPC	DSMI	MLO-LWG/-TLF	MME-MTS	
1	End-position controller CPX-CMPX	■	■	■	■	■	7
2	Proportional directional control valve VPWP	■	■	■	■	■	vpwp
4	Sensor interface CASM-S-D2-R3	-	-	■	■	-	casm
5	Sensor interface CASM-S-D3-R7	-	■	-	-	-	casm
6	Connecting cable KVI-CP-3-...	■	■	■	■	■	10
7	Connecting cable NEBC-P1W4-...	-	-	■	■ / -	-	nebc
8	Connecting cable NEBC-A1W3-...	-	-	-	- / ■	-	nebc
-	Connecting cable NEBP-M16W6-...	-	-	-	-	■	vpwp

# End-position controllers CPX-CMPX

Type codes and peripherals overview

## Type codes

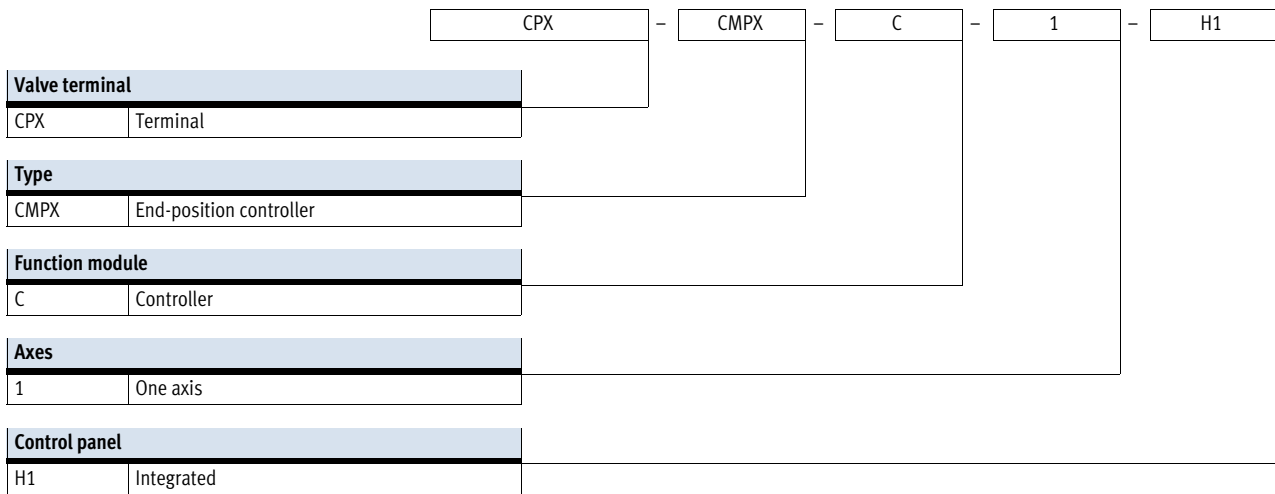

## Peripherals overview

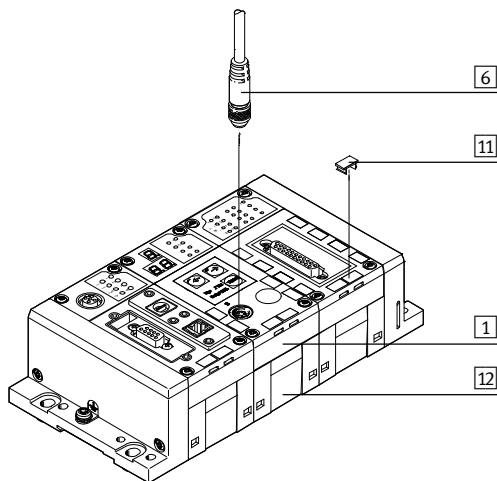

Accessories			
Type	Brief description		→ Page/Internet
1	End-position controller CPX-CMPX	Integrated in the CPX terminal. Screws for mounting on the plastic interlinking block are included in the scope of delivery.	8
6	Connecting cable KVI-CP-3	For connecting end-position controller CPX-CMPX and proportional directional control valve VPWP.	10
11	Inscription label IBS	For labelling the modules.	10
12	Interlinking block CPX-GE	Connects the individual modules. Two versions are available: plastic or metal interlinking block.	11
-	Screws CPX-M-M3	For mounting on the metal interlinking block.	10

# End-position controllers CPX-CMPX

## Technical data

The end-position controller CPX-CMPX is intended exclusively for use in valve terminals CPX.



General technical data			
Operating voltage			
Operating voltage range	[V DC]	18 ... 30	
Nominal operating voltage	[V DC]	24	
Current consumption at nominal operating voltage	[mA]	80	
Load voltage			
Load voltage range	[V DC]	20 ... 30	
Nominal load voltage	[V DC]	24	
Perm. load current	[A]	2.5	
Number of axes per module			
		1	
Length of connecting cable to axis	[m]	≤ 30	
Max. no. of modules			
		9	
Display			
		7-segment display	
Control elements			
		3 keys	
Assigned addresses	Outputs	[bit]	6x8
	Inputs	[bit]	6x8
Diagnostics			
		Module-orientated	
		Via local 7-segment display	
Status display			
		Module status	
		Power Load	
Control interface			
Data		CAN bus with Festo protocol	
		Digital	
Electrical connection		5-pin	
		M9	
		Socket	
Materials: Housing			
		Reinforced PA	
Product weight	[g]	240	
Dimensions	Length	[mm]	107
	Width	[mm]	50
	Height	[mm]	55

# End-position controllers CPX-CMPX

Technical data

Operating and environmental conditions		
Ambient temperature	[°C]	-5 ... +50
Relative air humidity	[%]	5 ... 95, non-condensing
Protection class to IEC 60529		IP65
CE mark (see declaration of conformity)		To EU EMC Directive

## Connection and display components

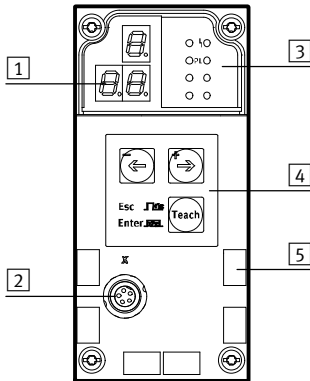

- 1 3-digit display
- 2 Control interface
- 3 Status LEDs
- 4 Operating buttons
- 5 Inscription labels

Pin allocation – Control interface			
	Pin	Signal	Designation
	1	+24 V	Nominal operating voltage
	2	+24 V	Load voltage
	3	0 V	Ground
	4	CAN_H	CAN high
	5	CAN_L	CAN low
	Housing	Screened	Cable screening

Permitted bus nodes/CEC		
Bus node/CEC	Protocol	Max. no. of CMPX modules
CPX-CEC...	-	9
CPX-FB6	INTERBUS	2
CPX-FB11	DeviceNet <sup>1)</sup>	9
CPX-FB13	PROFIBUS <sup>2)</sup>	9
CPX-FB14	CANopen	5
CPX-M-FB21	INTERBUS	2
CPX-FB23-24	CC-Link	5 (function module F23)
		9 (function module F24)
CPX-FB33	PROFINET RT, M12	9
CPX-M-FB34	PROFINET RT, RJ45	9
CPX-M-FB35	PROFINET RT, SCRJ	9
CPX-FB36	EtherNet/IP	9
CPX-FB37	EtherCAT	9
CPX-FB39	Sercos III	9
CPX-FB40	POWERLINK	9
CPX-M-FB41	PROFINET RT	9

1) With Revision 20 (R20)  
 2) With Revision 23 (R23)

PROFIBUS®, DeviceNet®, CANopen®, INTERBUS®, CC-LINK®, EtherCAT®, PROFINET®, Sercos®, EtherNet/IP® is a registered trademark of its respective trademark holder in certain countries.

# End-position controllers CPX-CMPX

Accessories

**FESTO**

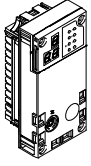
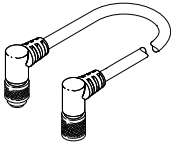
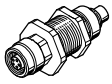
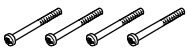
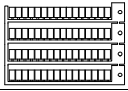
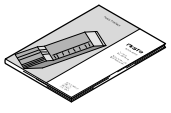

Ordering data		Brief description	Part No.	Type
<b>End-position controller</b>				
	Order code in the CPX configurator: T20		<b>548931</b>	<b>CPX-CMPX-C-1-H1</b>
<b>Connecting cables</b>				
	Connecting cable with angled plug and angled socket	0.25 m	<b>540327</b>	<b>KVI-CP-3-WS-WD-0,25</b>
		0.5 m	<b>540328</b>	<b>KVI-CP-3-WS-WD-0,5</b>
		2 m	<b>540329</b>	<b>KVI-CP-3-WS-WD-2</b>
		5 m	<b>540330</b>	<b>KVI-CP-3-WS-WD-5</b>
		8 m	<b>540331</b>	<b>KVI-CP-3-WS-WD-8</b>
	Connecting cable with straight plug and straight socket	2 m	<b>540332</b>	<b>KVI-CP-3-GS-GD-2</b>
5 m		<b>540333</b>	<b>KVI-CP-3-GS-GD-5</b>	
8 m		<b>540334</b>	<b>KVI-CP-3-GS-GD-8</b>	
	Connector for control cabinet through-feed		<b>543252</b>	<b>KVI-CP-3-SSD</b>
<b>Screws</b>				
	For mounting on the metal interlinking block		<b>550219</b>	<b>CPX-M-M3X22-4X</b>
<b>Inscription labels</b>				
	Inscription labels 6x10, in frames	64 pieces	<b>18576</b>	<b>IBS-6X10</b>
<b>User manual</b>				
	End-position controller description CPX-CMPX <sup>1)</sup>	German	<b>555479</b>	<b>P.BE-CPX-CMPX-SYS-DE</b>
		English	<b>555480</b>	<b>P.BE-CPX-CMPX-SYS-EN</b>
		Spanish	<b>555481</b>	<b>P.BE-CPX-CMPX-SYS-ES</b>
		French	<b>555482</b>	<b>P.BE-CPX-CMPX-SYS-FR</b>
		Italian	<b>555483</b>	<b>P.BE-CPX-CMPX-SYS-IT</b>

1) User manual in paper form is not included in the scope of delivery.

# End-position controllers CPX-CMPX

Accessories

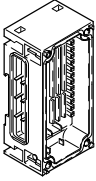

Ordering data				
	Brief description		Part No.	Type
Interlinking block, plastic, as expansion block				
	Without power supply	–	<b>195742</b>	<b>CPX-GE-EV</b>
	With additional power supply for outputs	M18 – 4-pin	<b>195744</b>	<b>CPX-GE-EV-Z</b>
		7/8" – 5-pin	<b>541248</b>	<b>CPX-GE-EV-Z-7/8-5POL</b>
		7/8" – 4-pin	<b>541250</b>	<b>CPX-GE-EV-Z-7/8-4POL</b>
	With additional power supply for valves	M18 – 4-pin	<b>533577</b>	<b>CPX-GE-EV-V</b>
		7/8" – 4-pin	<b>541252</b>	<b>CPX-GE-EV-V-7/8-4POL</b>
Tie rods				
	For expansion using an interlinking block	1-fold	<b>525418</b>	<b>CPX-ZA-1-E</b>

# Festo - Your Partner in Automation



**1 Festo Inc.**  
5300 Explorer Drive  
Mississauga, ON L4W 5G4  
Canada

**Festo Customer Interaction Center**  
Tel: 1 877 463 3786  
Fax: 1 877 393 3786  
Email: [customer.service.ca@festo.com](mailto:customer.service.ca@festo.com)



**2 Festo Pneumatic**  
Av. Ceylán 3,  
Col. Tequesquináhuac  
54020 Tlalneantla,  
Estado de México

**Multinational Contact Center**  
01 800 337 8669  
[ventas.mexico@festo.com](mailto:ventas.mexico@festo.com)



**3 Festo Corporation**  
1377 Motor Parkway  
Suite 310  
Islandia, NY 11749

**Festo Customer Interaction Center**  
1 800 993 3786  
1 800 963 3786  
[customer.service.us@festo.com](mailto:customer.service.us@festo.com)



**4 Regional Service Center**  
7777 Columbia Road  
Mason, OH 45040

Connect with us



[www.festo.com/socialmedia](http://www.festo.com/socialmedia)



[www.festo.com](http://www.festo.com)

Subject to change