

Inscription labels ASLR

Technical data

Inscription label KM-BZ, IBS, KMC, MH, ASLR

Inscription labels for identification, can be used in holders or carriers on suitably equipped components.

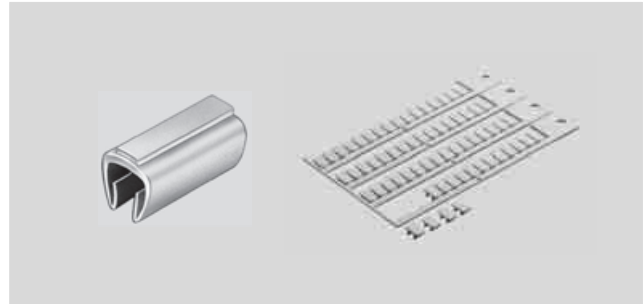





General technical data					
Type	KM-BZ	IBS	KMC/F	MH	ASLR
Type of mounting	Inscription label holder is pressed onto a cable	Pressed into inscription label holders or suitable slots on the components	Label (self-adhesive) is on the component		
Labelling	The inscription label holder itself is not labelled. The inscription consists of an insertable label or paper/ cardboard strips	By the user directly on the inscription label	The inscription label holder already has a label.		
Cable diameter [mm]	5 ... 8	–	–		

Materials						
Type	KM-BZ	IBS	IBS-8x20	KMC/F	MH	ASLR
Inscription label holders	–	PA	PA	PA	PC	–
Note on materials	–	–	RoHS-compliant	–	–	RoHS-compliant

Inscription labels ASLR

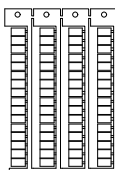
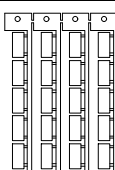
Technical data

FESTO

Ordering data					
	Description	Dimensions (HxW) [mm]	Scope of delivery	Part No.	Type
	Inscription clips for placing on a cable	11x20	1	33361	KM-BZ
	Inscription labels for pressing into a holder	6x10	64 (number per frame)	18576	IBS-6x10
		9x17	24 (number per frame)	161937	IBS-9x17
	Inscription labels for pressing into a holder	8x20	20 (number per frame)	539388	IBS-8x20
		9x20	20 (number per frame)	18182	IBS-9x20
	Inscription labels for pressing into a holder	11/8x17	35 (number per frame)	33362	KMC/F/V-BZ-35X
	Inscription labels for pressing into a holder	4.5x9	80 (number per frame)	197259	MH-BZ-80X
	Inscription label holder, labelled <ul style="list-style-type: none"> • 4 inscription labels, duct 1/3/5 • 4 inscription labels, duct 1 • 4 inscription labels, duct 3/5 	20x16	3x4 pieces	8003303	ASLR-L-S6-2016

Festo - Your Partner in Automation



1 Festo Inc.
5300 Explorer Drive
Mississauga, ON L4W 5G4
Canada

Festo Customer Interaction Center
Tel: 1 877 463 3786
Fax: 1 877 393 3786
Email: customer.service.ca@festo.com



2 Festo Pneumatic
Av. Ceylán 3,
Col. Tequesquináhuac
54020 Tlalnepantla,
Estado de México

Multinational Contact Center
01 800 337 8669
ventas.mexico@festo.com



3 Festo Corporation
1377 Motor Parkway
Suite 310
Islandia, NY 11749

Festo Customer Interaction Center
1 800 993 3786
1 800 963 3786
customer.service.us@festo.com



4 Regional Service Center
7777 Columbia Road
Mason, OH 45040

Connect with us



www.festo.com/socialmedia



www.festo.com

Subject to change